

Type of Course	Long course
Targets	14 IPSC Targets, 2 IPSC Poppers, 2 Mini Poppers, NO shoots
Rounds to be scored	32
Possible points	160
Start position	Standing , hills touching the black line.
Gun state	Ready condition
Time starts	Audible signal
Procedure	At the start signal engage targets from within the designated area.

Stage 2

11 rounds

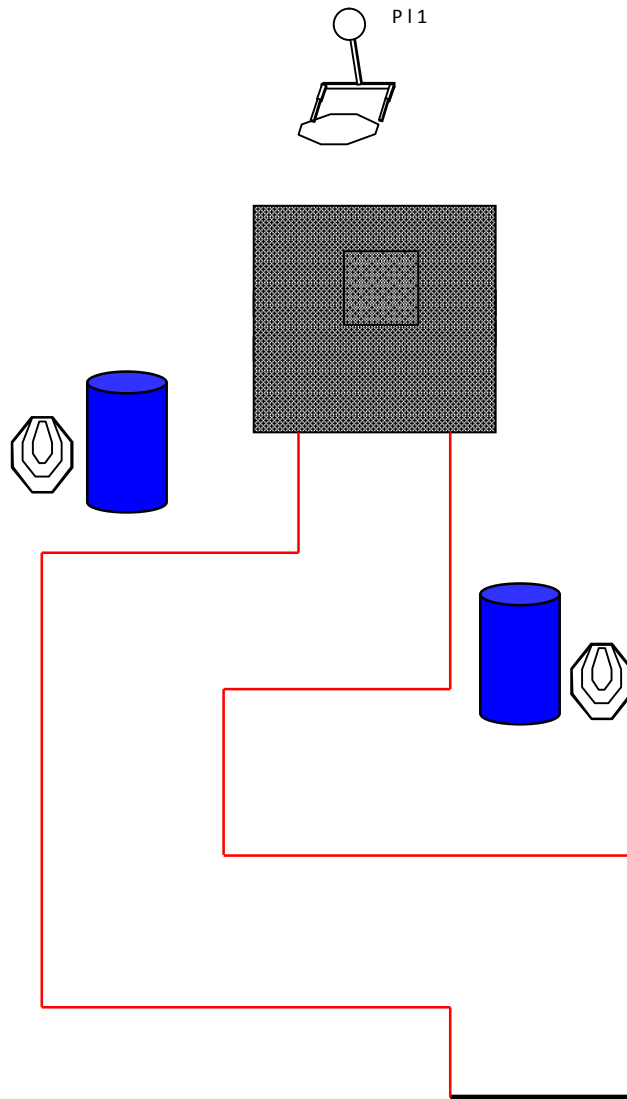

Type of Course	Short course
Targets	5 IPSC Targets, 1 Metal Plate, No shoots
Rounds to be scored	11
Possible points	55
Start position	Standing , heels touching the black line.
Gun state	Ready condition
Time starts	Audible signal
Procedure	At the start signal engage targets from within the designated area.

Stage 3

9 rounds

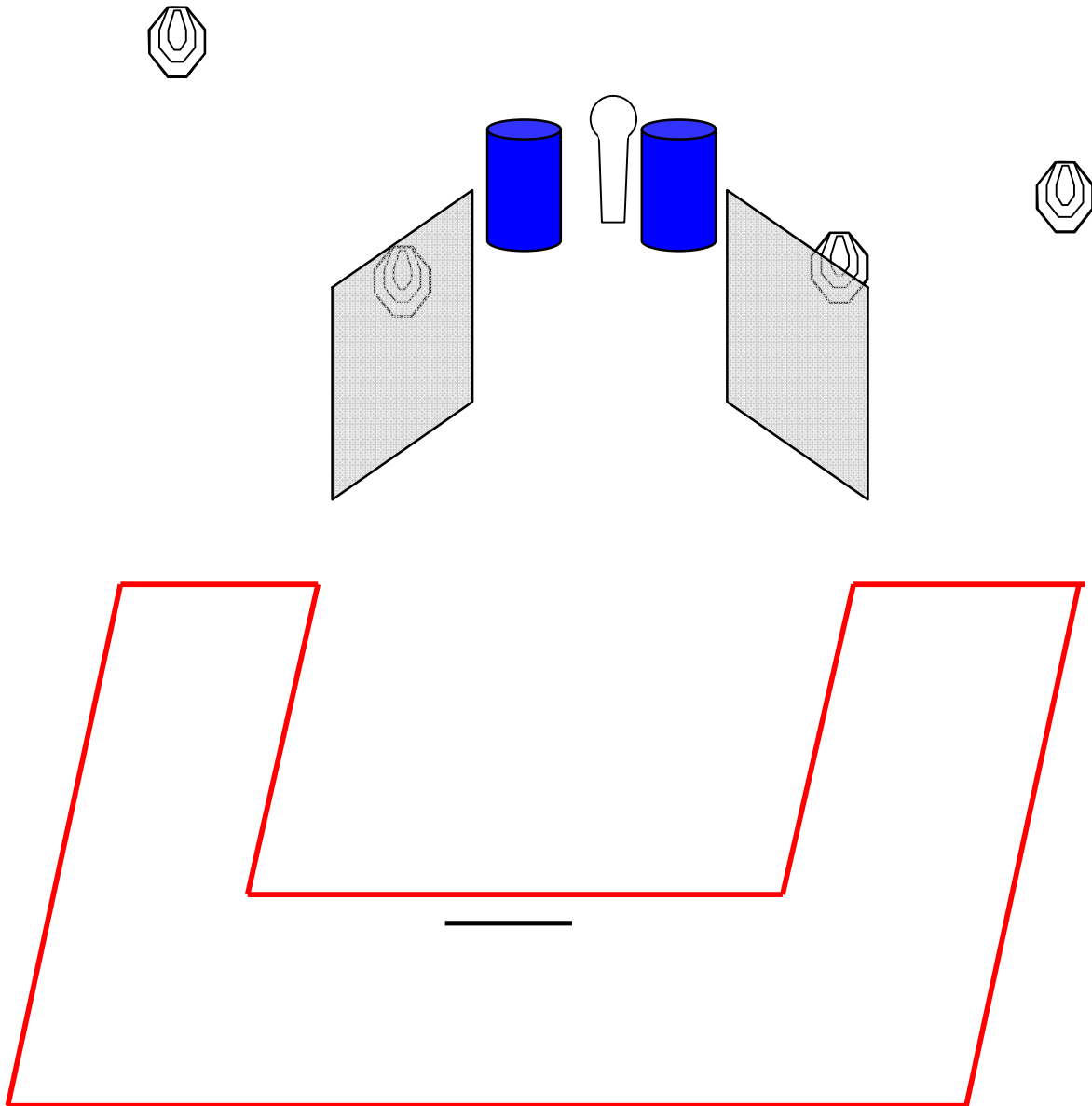

Type of Course	Short course
Targets	4 IPSC Targets, 1 IPSC
Rounds to be scored	9
Possible points	45
Start position	Standing , top of the boots touching the black line.
Gun state	Chamber empty, magazine inserted
Time starts	Audible signal
Procedure	At the start signal engage targets from within the designated area. Weak hand only

Stage 4

22 rounds

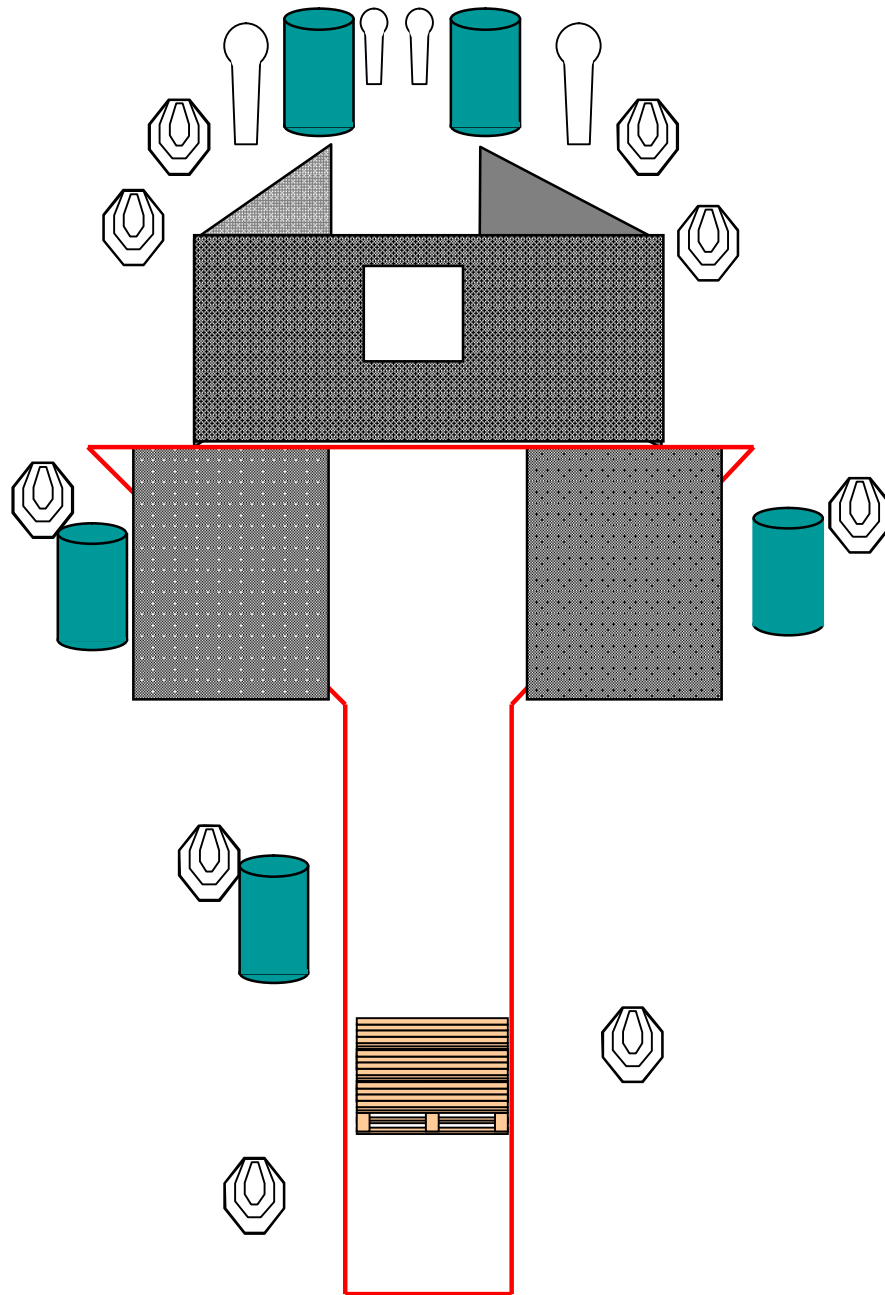

Type of Course	Medium course
Targets	9 IPSC Targets, 2 IPSC Poppers, 2 IPSC Mini Poppers
Rounds to be scored	22
Possible points	110
Start position	Standing, anywhere in marked area
Gun state	Ready condition
Time starts	Audible signal
Procedure	At the start signal engage targets from within the designated area.

Stage 5

24 rounds

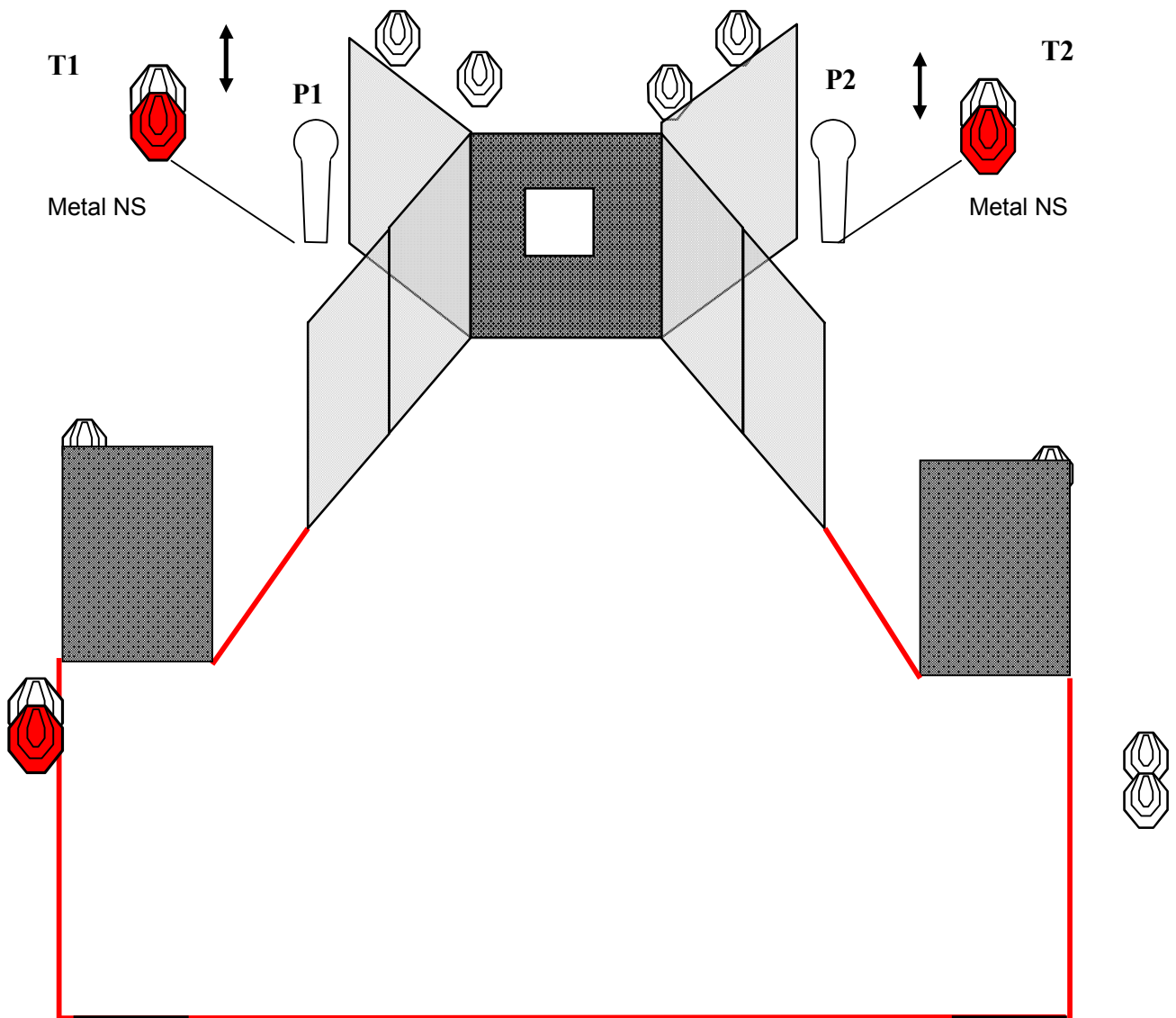

Type of Course	Medium course
Targets	11 IPSC Targets, 2 IPSC Popper, No shoots
Rounds to be scored	24
Possible points	120
Start position	Standing , heels touching the black line.
Gun state	Chamber empty, all magazines on the belt
Time starts	Audible signal
Procedure	At the start signal engage targets from within the designated area. P1 activate T1. P2 activate T2. All moving targets remain visible at rest.

Stage 6

12 rounds

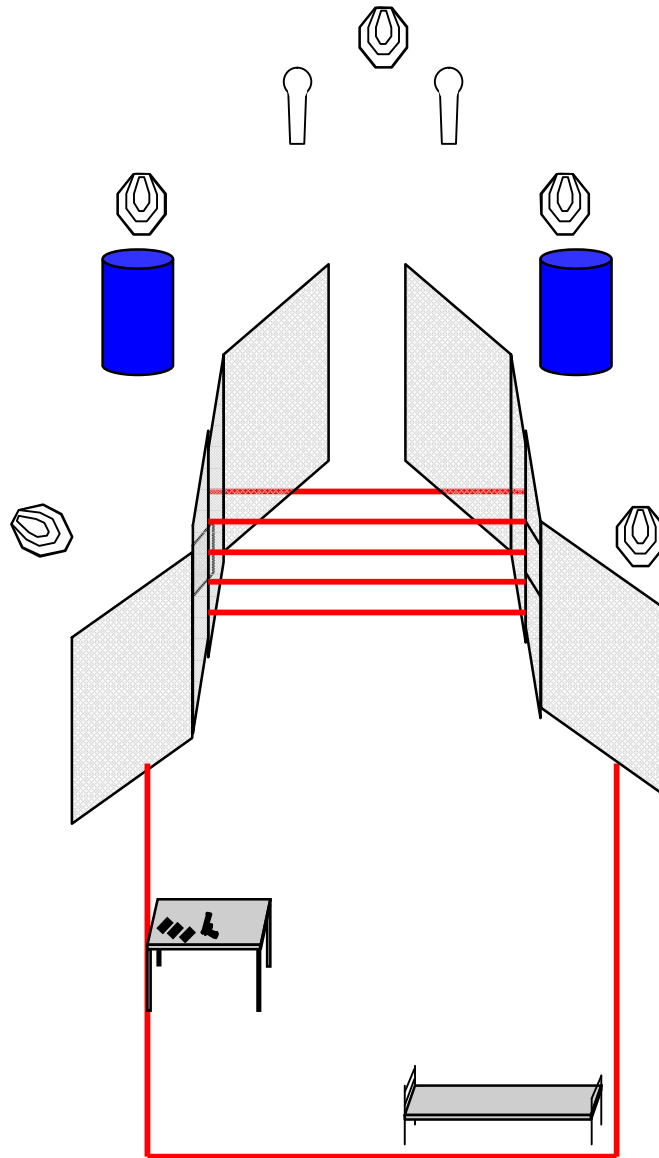

Type of Course	Short course
Targets	5 IPSC Targets, 2 IPSC Mini Poppers,
Rounds to be scored	12
Possible points	60
Start position	The competitor lies on the bed, as demonstrated by RO.
Gun state	Chamber and magwell empty laying on the table downrange and all magazines on the table.
Time starts	Audible signal
Procedure	At the start signal engage targets from within the designated area. Cooper tunnel.

Stage 7

21 rounds

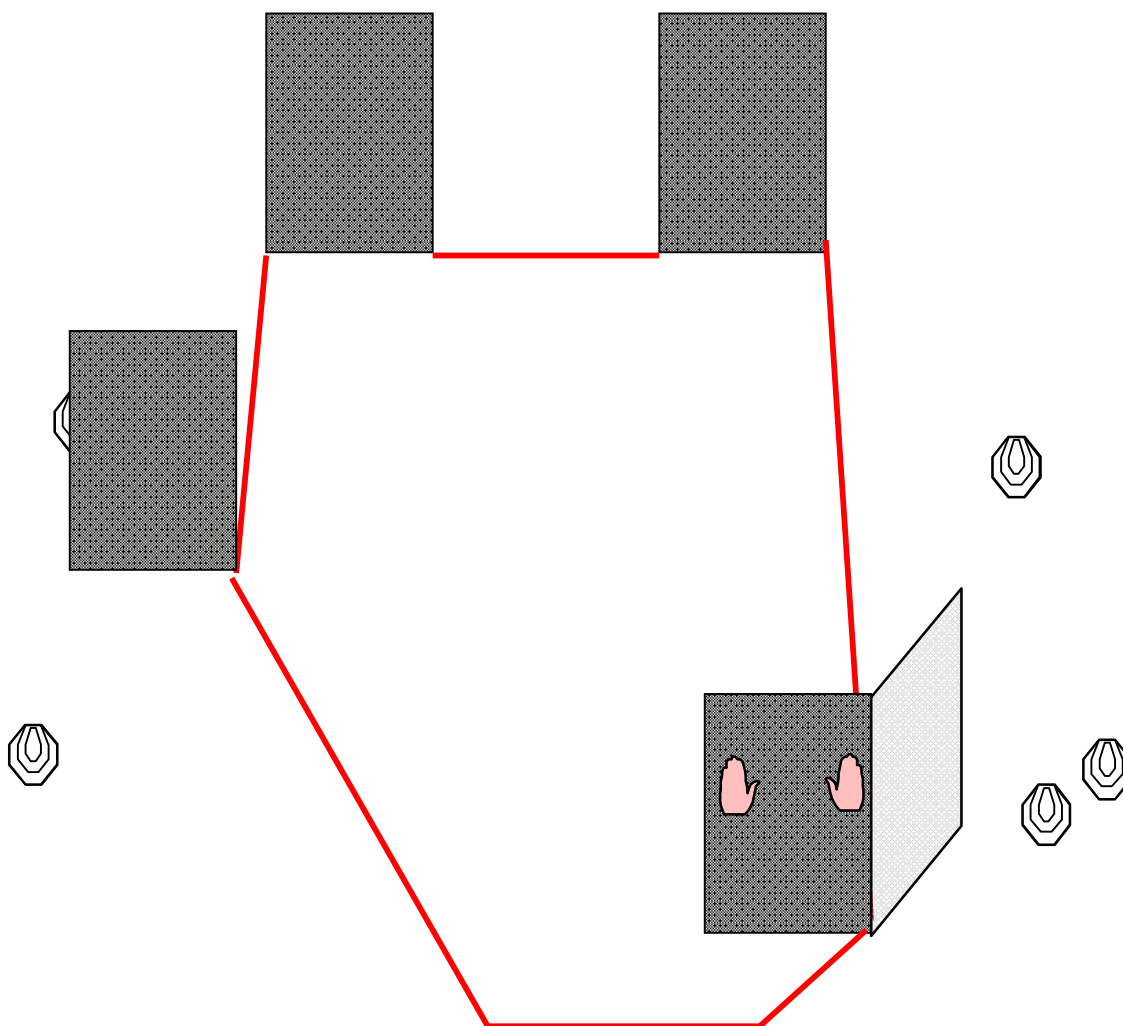
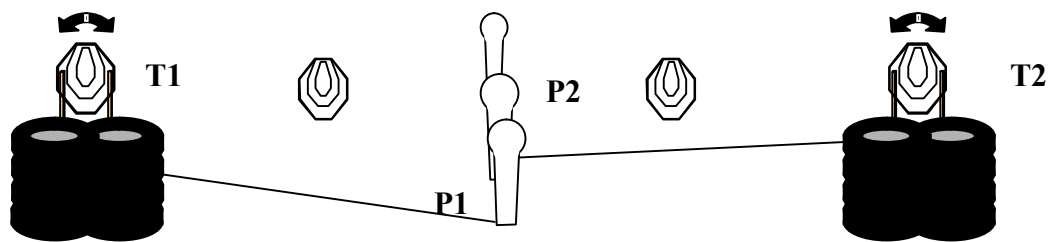

Type of Course	Medium course
Targets	9 IPSC Targets, 2 IPSC Poppers, 1IPSC Mini Popper
Rounds to be scored	21
Possible points	105
Start position	Standing , palms touching the marked area.
Gun state	Ready condition
Time starts	Audible signal
Procedure	At the start signal engage targets from within the designated area. P1 activate T1. P2 activate T2. All moving targets remain visible at rest.

Stage 8

9 rounds

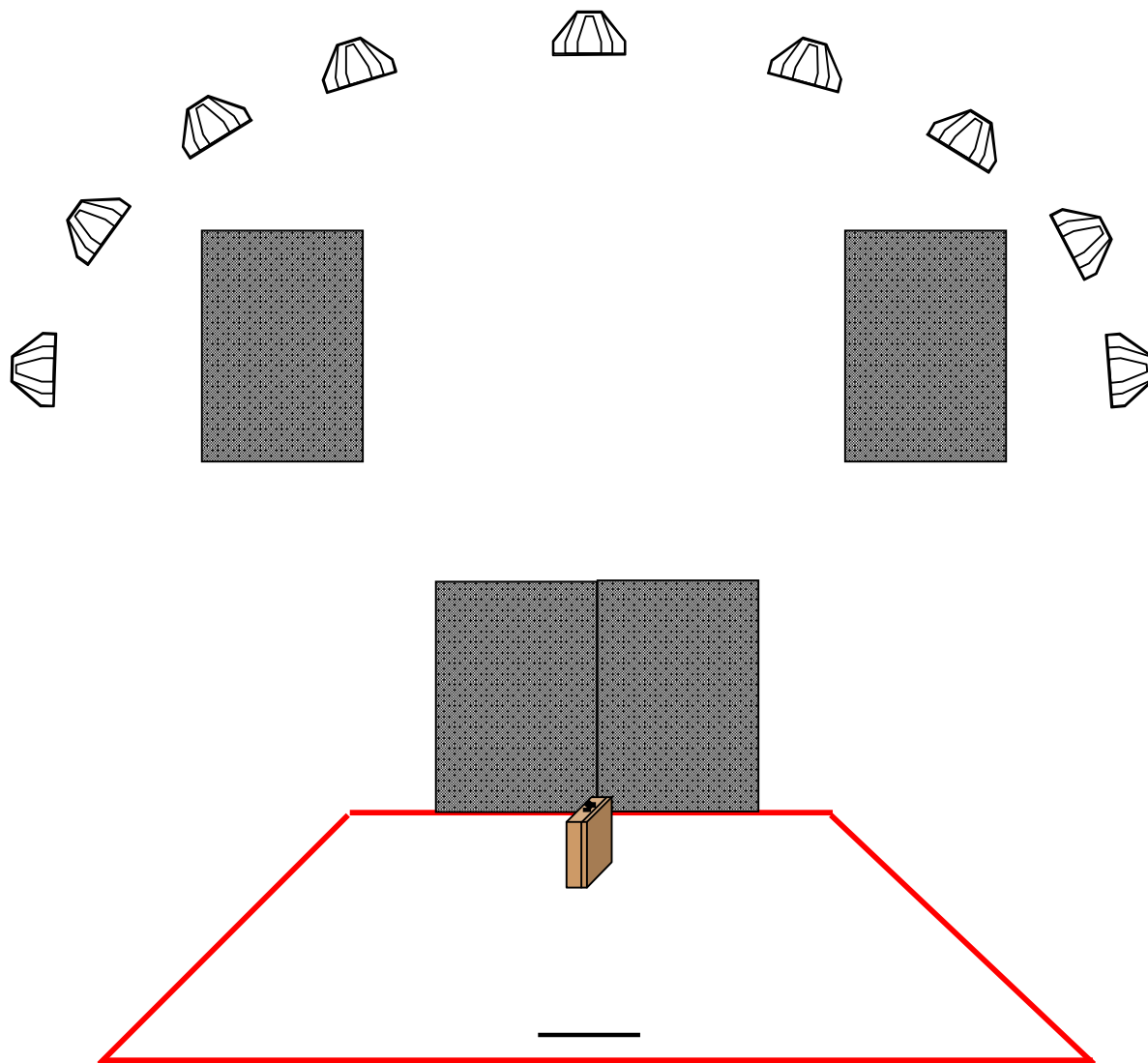

Type of Course	Short course
Targets	9 IPSC Targets
Rounds to be scored	9
Possible points	45
Start position	Standing , heels touching the black line.
Gun state	Ready condition
Time starts	Audible signal
Procedure	At the start signal engage targets from within the designated area. STRONG hand only. One shot minimum per target. Weak hand hold the briefcase at course of fire.

Stage 9

22 rounds

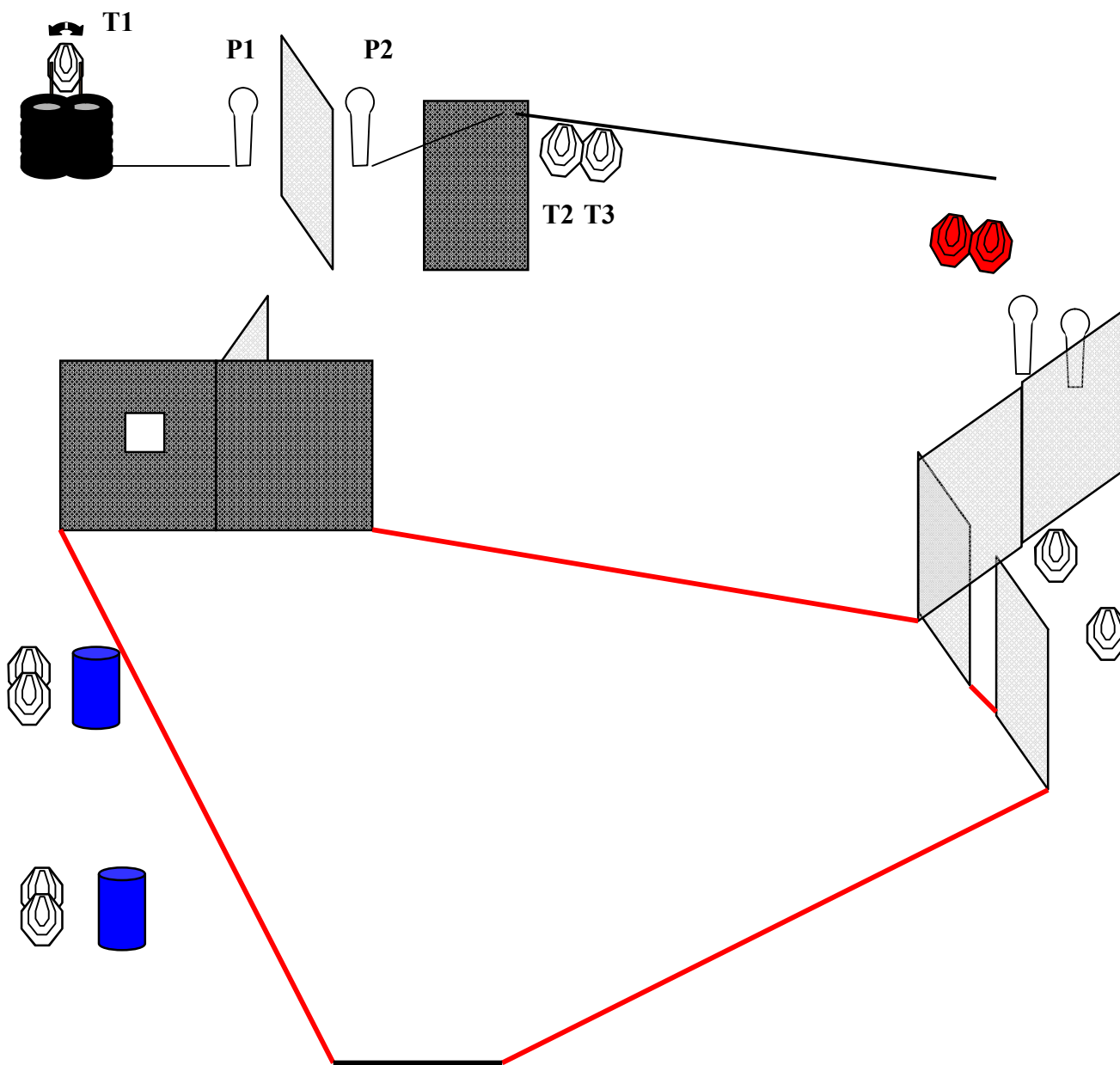

Type of Course	Long course
Targets	14 IPSC Targets, 4 IPSC Poppers
Rounds to be scored	32
Possible points	160
Start position	Standing , heels touching the black line.
Gun state	Ready condition
Time starts	Audible signal
Procedure	At the start signal engage targets from within the designated area. P1 activate T1. P2 activates T2, T3. All moving targets remain visible at rest.

Stage 10

11 rounds

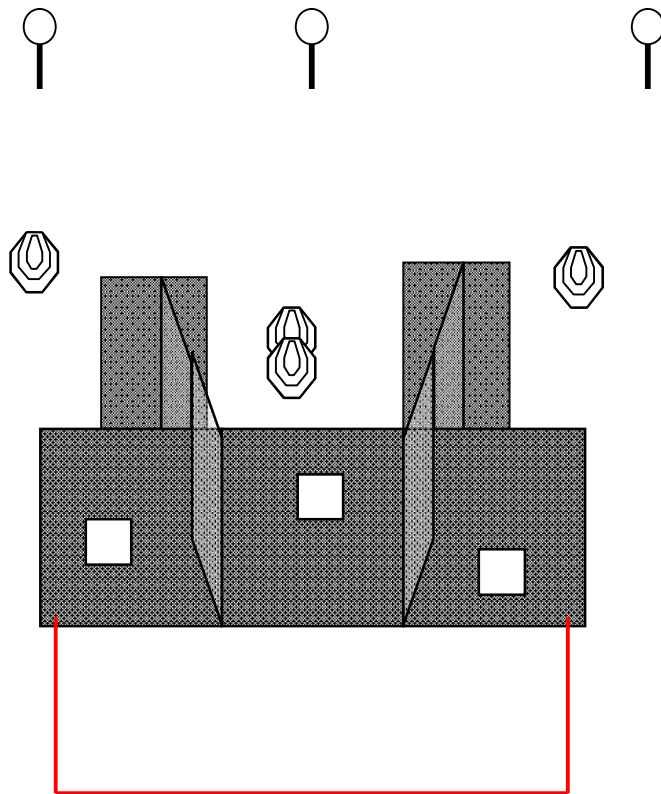

Type of Course	Short course
Targets	4 IPSC Targets, 3 IPSC Metal plates
Rounds to be scored	11
Possible points	55
Start position	Standing, anywhere in marked area
Gun state	Chamber empty
Time starts	Audible signal
Procedure	At the start signal engage targets from within the designated area.

Stage 11

30 rounds

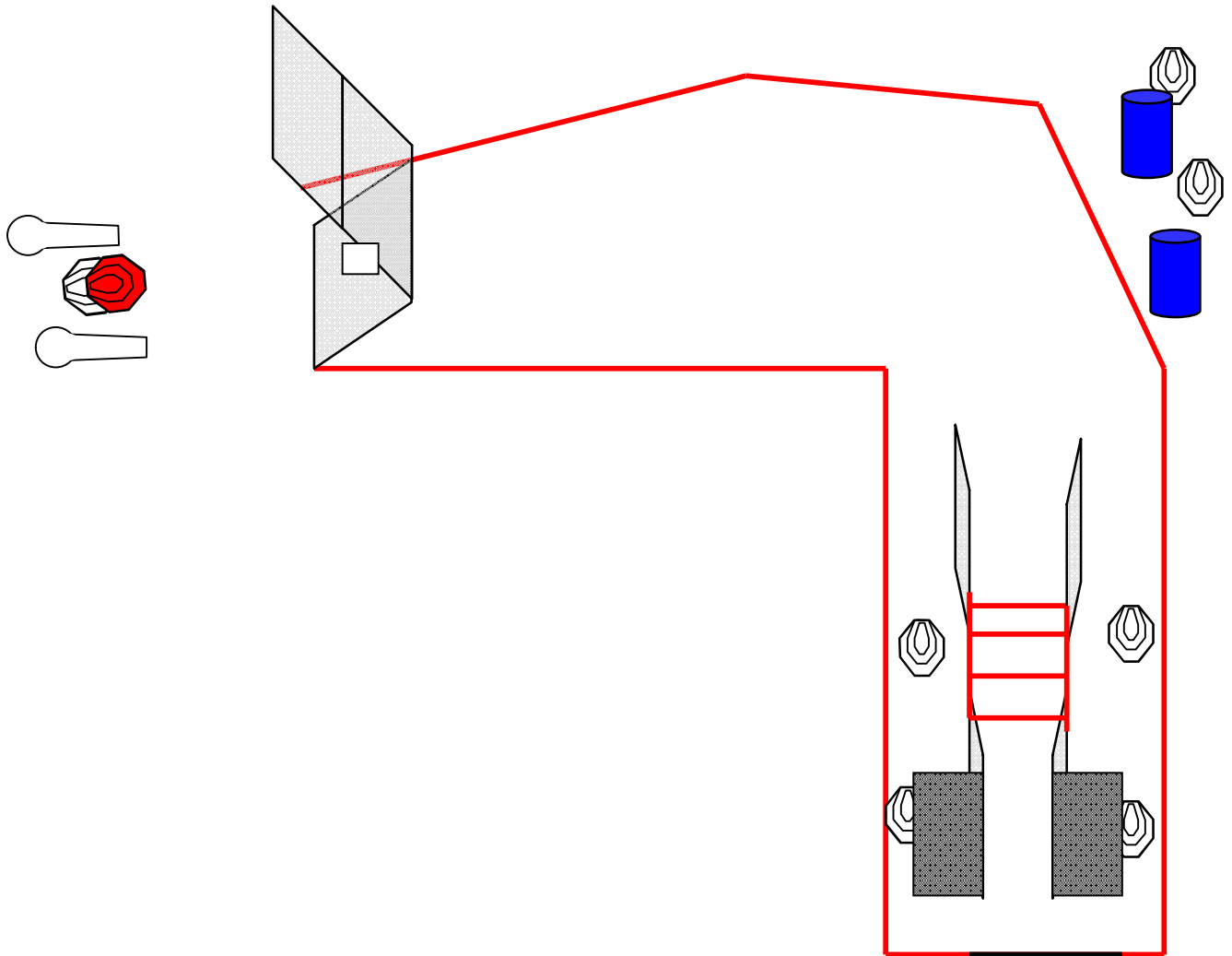
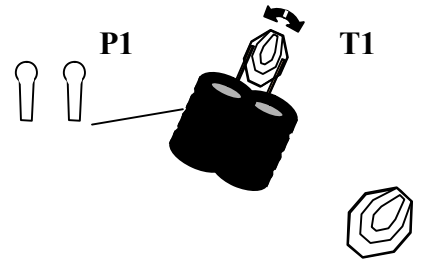
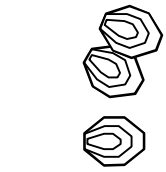

Type of Course	Long course
Targets	13 IPSC Targets, 2 IPSC Poppers, 2 IPSC Mini Poppers, NO shoots
Rounds to be scored	30
Possible points	150
Start position	Standing , heels touching the black line.
Gun state	Ready condition
Time starts	Audible signal
Procedure	At the start signal engage targets from within the designated area. P 1 activat T 1. All moving targets remain visible at rest.

Stage 12

11 rounds

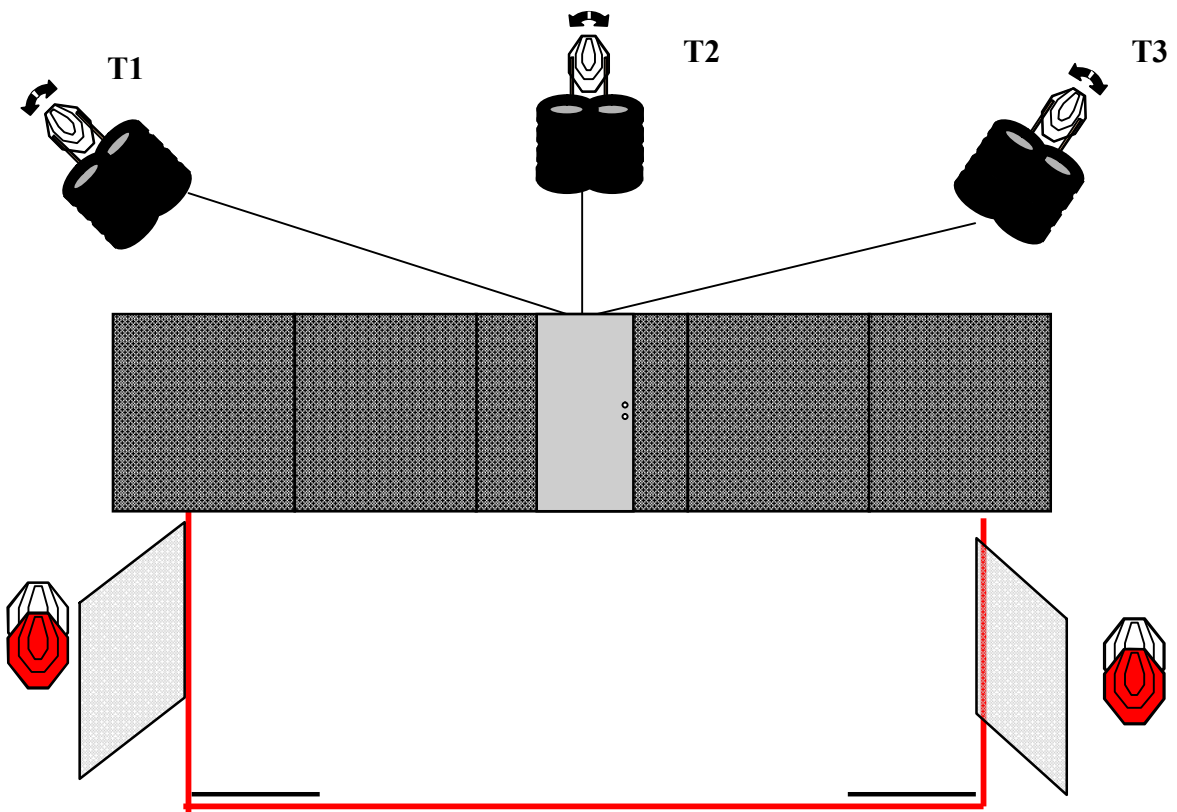

Type of Course	Short course
Targets	5 IPSC Targets, 1 IPSC Mini Popper, NO shoots
Rounds to be scored	11
Possible points	55
Start position	Standing , heels touching the black line.
Gun state	Ready condition
Time starts	Audible signal
Procedure	At the start signal engage targets from within the designated area. The door activate T1, T2, T3. All moving targets remain visible at rest.